

INDUSTRIAL EXT. REACH PLP PULLDOWN FAUCET / 2PC. SUITE

9700-2

- Max Counter Thickness 2-3/8"
- Minimum Install Hole Size 1-1/2"

- A. Spray Connection with 3/8" Compression Fitting
- B. Supply Hoses - 20" Long with 3/8" Compression Fittings

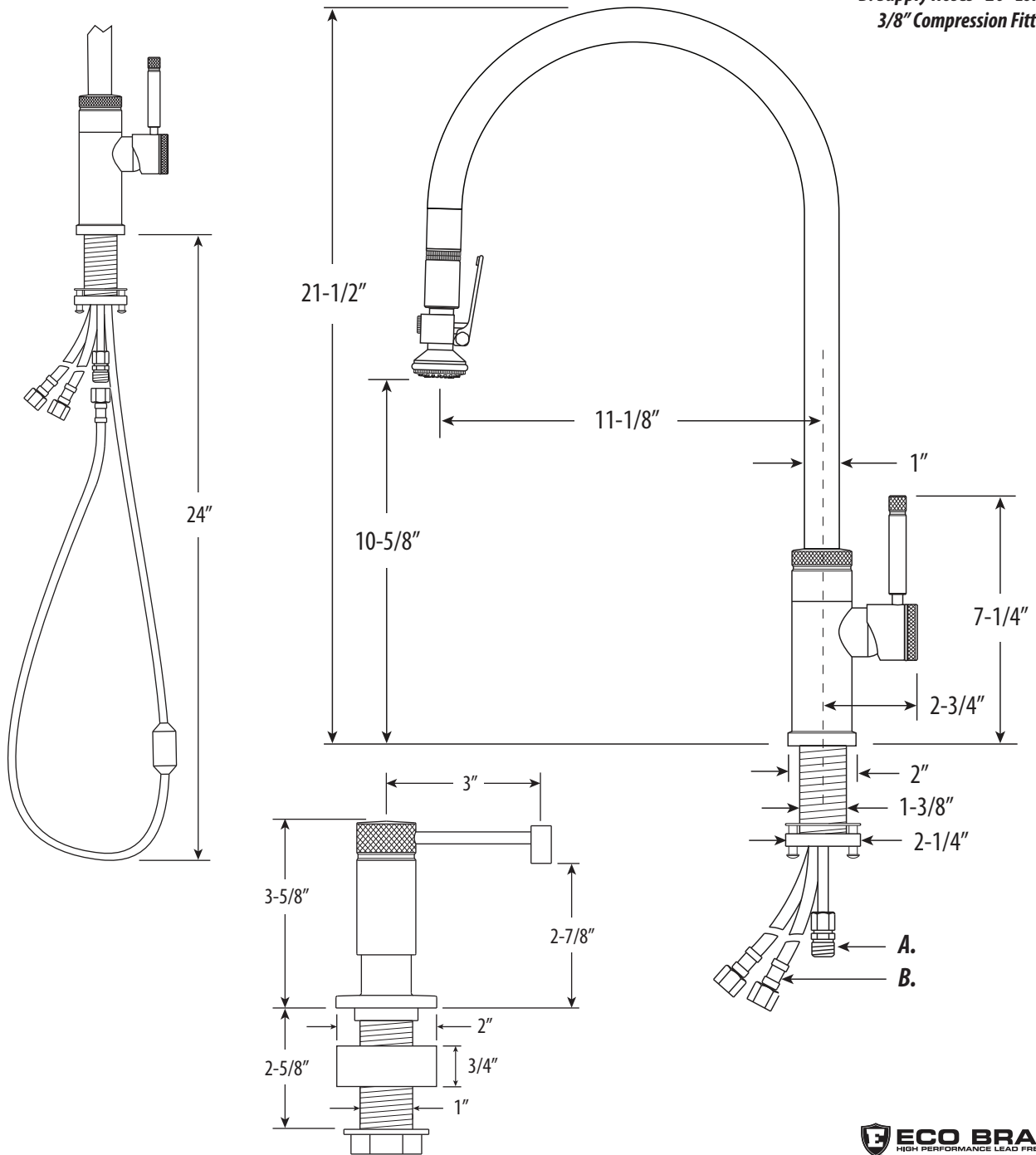

DIMENSIONS MAY VARY AND ARE SUBJECT TO CHANGE. NO RESPONSIBILITY IS ASSUMED FOR USE OF SUPERCEDED OR VOIDED DATA