







FMIU020X



Product family	Microwave oven
Category	Built-in
Installation	With frame
Power source	Electrical
Cooking Method	Microwave with grill
Oven controls	Electro-mechanical



Programs / Functions

Number of functions	6
Large grill	
Pizza	
Defrost by time	
Defrost by weight	
Microwave	
Microwave + grill	
Automatic programs	8

Controls

Display	1 LED	No. of controls	1
Controls	Controls knobs / Buttons	Control knobs	Push-push
Opening	Button	Controls color	Stainless steel effect

Options



Timer	Electronic	Child safety lock	Yes
Time-setting options	End-of-cooking	Quick-start option	Yes
End-of-cooking acoustic alarm	Yes		

Technical Features



Cavity material	Stainless steel	Grill - power	1000 W
No. of lights	1	Total no. of door glasses	1
Lighting	LED	Security Thermostat	Yes
Turntable	Yes	Cooling system	Tangential
Turntable dimensions	9 5/8 "	Microwave door protection screen	Yes
Light on when door is open	Yes	Microwave stops when door is opened	Yes
Grill type	Heating element	Microwave effective power	800 W

Accessories Included







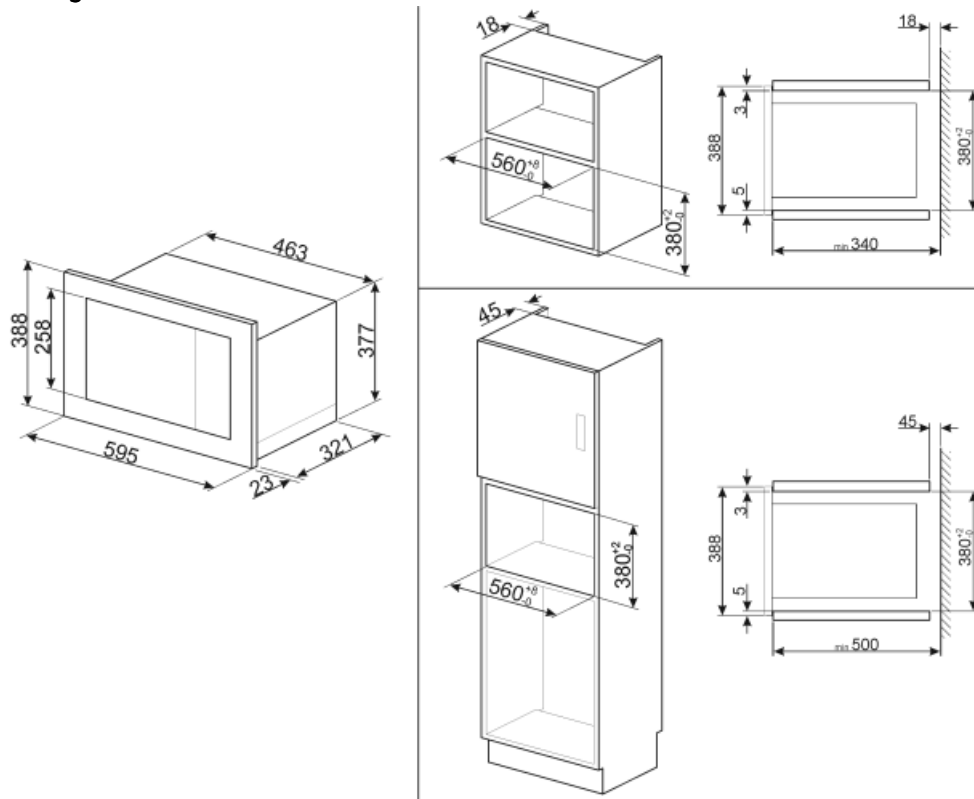



Grid	1	Frame	Yes
-------------	---	--------------	-----

Electrical Connection

Nominal power	1350 W	Frequency	60 Hz
Current	11 A	Power cord length	59 1/16 "
Voltage	120 V		



Symbols glossary (TT)

- | | | | |
|------------------------------------------------------------------------------------|---------------------------------------------------------------------------------------------------------------------------------------------------------------------------------------------------------------|-------------------------------------------------------------------------------------|------------------------------------------------------------------------------------------------------------------------------------------------------------------------------------------------------------------------------------------------------------------------------------------------------------------------------------------------------------------------------------------|
|  | Child lock: some models are fitted with a device to lock the programme/cycle so it cannot be accidentally changed. |  | Microwave energy shortens cooking times dramatically and produces energy savings. |
|  | Defrost by time: with this function the time of thawing of foods are determined automatically. |  | Defrost by weight: With this function the defrosting time is determined |
|  | Grill element: Using of grill gives excellent results when cooking meat of medium and small portions, especially when combined with a rotisserie (where possible). Also ideal for cooking sausages and bacon. |  | Microwave: Penetrating straight into the food, microwaves cook very quickly and with considerable energy savings. Suitable for cooking without fat, they are also able to thaw and heat food without altering its original appearance and aroma. The microwave function can also be combined with conventional functions with all the resulting advantages. Ideal for all types of food. |
|  | Microwave + grill element: The use of the grill results in a perfect browning of the surface of the food. The action of microwaves allows instead of cooking in a short time the internal part of the food. |  | Pizza microwave: This function cooks pizza quicker thanks to the microwaves. To optimize the final result, use the function combined with the Chef plate |
|  | Side lights: Two opposing side lights increase visibility inside the oven. |  | The capacity indicates the amount of usable space in the oven cavity in litres. |