

# ORION MOUD-804SB

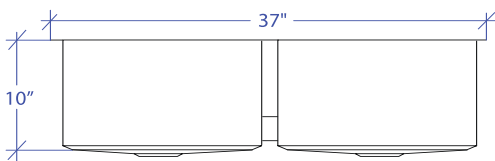

\*Custom ADA compliant sinks are available

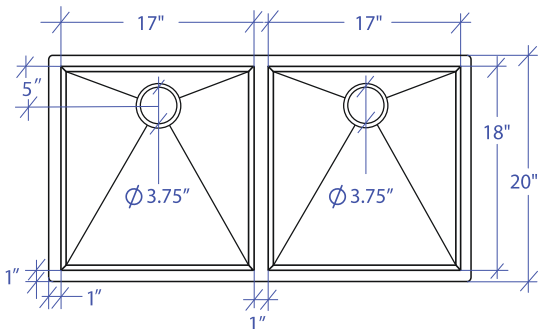

## • FEATURES

16-gauge type 304 stainless steel  
Bevel basin design

## • TECHNICAL INFORMATION

External dimension: 37"Lx20"Wx10"D  
Basin dimensions:  
Left: 17"Lx18"Wx10"D  
Right: 17"Lx18"Wx10"D

## • FINISHES

Satin Brushed stainless steel

## • INSTALLATION OPTIONS

Top-mount  
Under-mount

## • MINIMUM CABINET SIZE (I.D.)

Top-mount 38"  
Under-mount 40"

## • US DESIGN PATENT D618,324 S

## • DUAL-MOUNT INSTALLATION

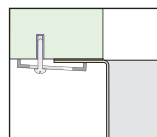

Under-mount

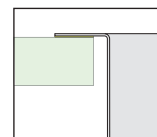

Top-mount

## • ACCESSORY OPTIONS

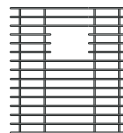

MBG-083SB  
Basin Grid

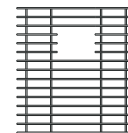

MBG-083SB  
Basin Grid

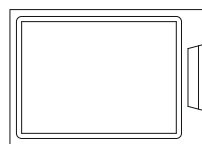

MCB-801BB  
Cutting Board

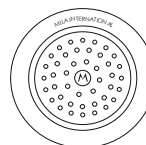

MKD-101SB  
Strainer

PROJECT INFORMATION			
Project			
Date	/ /	QTY	
Specifier			
Contact			
Note			