

## WARNING

**IMPORTANT: NEVER attempt any work without shutting off the electricity.**

- Read all instructions before installing.
- System is intended for installation by a qualified electrician in accordance with the National Electrical Code and local regulations.
- Go to the main fuse box, or circuit breaker. Place the main power switch in the "OFF" position and unscrew the fuse(s) or switch "OFF" the circuit breaker switch(es) that control the power to the fixture or room that you are working on.
- Place the wall switch in the "OFF" position.

## CAUTION

- All parts must be used as indicated in these instructions. Do not substitute any parts, leave parts out, or use any parts that are worn out or broken. Failure to follow this instruction could invalidate the ETL/CETL listing of this fixture.

**CAUTION** When handling the fixture, do not apply pressure to the LEDs. Hold the fixture by the base only.

## AVERTISSEMENT

**IMPORTANT : Coupez l'électricité avant TOUTE manipulation.**

- Lisez toutes les instructions avant d'installer.
- Système est destiné à être installé par un électricien qualifié en conformité avec le code national de l'électricité et les règlements locaux.
- Accédez au panneau central de disjoncteurs ou de fusibles de votre demeure et placez l'interrupteur principal en position d'arrêt (« OFF »).
- Placez l'interrupteur mural en position d'arrêt (« OFF »).

## MISE EN GARDE

- Toutes les pièces doivent être utilisées tel qu'il est indiqué dans ces instructions. Ne remplacez pas les pièces, n'en laissez pas de côté et ne les utilisez pas si elles sont usées ou brisées. Le non-respect de ces instructions peut annuler l'homologation ETL/CETL du luminaire.

## MISE EN GARDE

Ors de la manipulation de l'appareil, ne pas appliquer de pression à la LED, tenir l'appareil par la seule base.

## ADVERTENCIA





**IMPORTANTE: NUNCA intente hacer trabajos sin desconectar el suministro eléctrico.**

- Lea y comprenda todas las instrucciones e ilustraciones por completo antes de proceder con el ensamblaje e instalación de esta lámpara.
- Sistema está diseñado para ser instalado por un electricista calificado, de acuerdo con el código eléctrico nacional y las normas locales.
- Diríjase a la caja de fusibles o a la caja del interruptor de circuito principal en su hogar. Coloque el interruptor de alimentación principal en la posición "OFF" (APAGADO).
- Coloque el interruptor de la pared en la posición "OFF" (APAGADO).

## PRECAUCIÓN

- Todas las piezas deben usarse como lo indican estas instrucciones. No reemplace las piezas, noomita piezas durante la instalación ni utilice piezas gastadas o rotas. El incumplimiento de esta indicación podría invalidar la calificación ETL/CETL esta lámpara.

**PRECAUCIÓN** Al manipular el aparato, no aplique presión a los LED, mantenga el aparato en la base sólo.

Hardware	B1	C1	E1	H1	J1
					
	Junction Box Screw Qty: 2+1 extra	Wire Connector Qty: 3	Set Screw 1 Qty: 1 extra	Gasket Qty: 1 extra	Set Screw 2 Qty: 1 extra

## PREPARATION

1. Shut off the power at the circuit breaker and remove existing fixture, including the mounting hardware.
2. Carefully unpack your new fixture and lay out all the parts on a clear area. Be careful not to lose any small parts necessary for installation.

## CONNECTING THE WIRES (Fig. 2)

3. Connect the fixture wires to supply wires as shown in Fig. 2, making sure that all wire connectors (C1) are secured. If your outlet box has a green or bare copper ground wire, connect the fixture's ground wire to it. Otherwise, connect the fixture's ground wire directly to the mounting plate (D1) using the green screw provided. After wires are connected, tuck them carefully inside the junction box.

## MOUNTING THE FIXTURE (Fig. 1)

4. Secure the mounting plate (D1) to the junction box (A1) using the junction box screws (B1). The side of the mounting plate marked "GND" must face out.
5. Place the fixture frame (G1) over the mounting plate (D1) and secure with gasket (F1) mounting screws (E1, two at the bottom, J1, two at the top).
6. Put the glass (K1) to the fixture frame (G1) from the top and put the metal frame (H1) on the glass (K1) secure it to the mounting plate (D1) with screws (E1) and gasket (F1).

## COMPLETING THE INSTALLATION (Fig. 3)

7. To prevent moisture from entering the outlet box and causing a short, use clear caulking (i.e. indoor/outdoor silicone sealant) to outline the outside of fixture back plate where it meets the wall. Leave a space at the bottom to allow moisture to escape (Fig.3)..

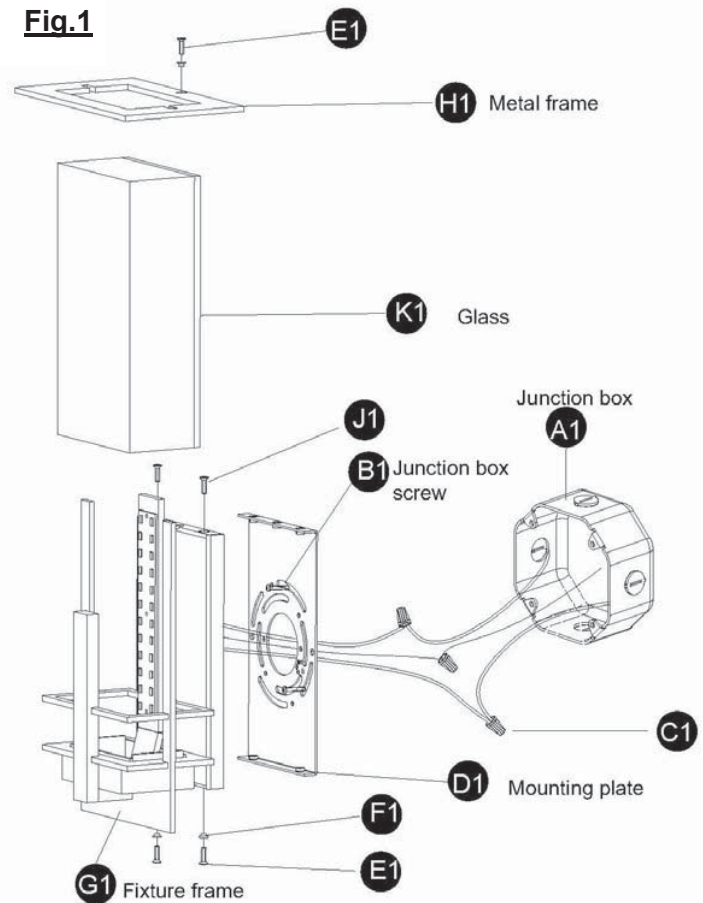

**Fig. 2**

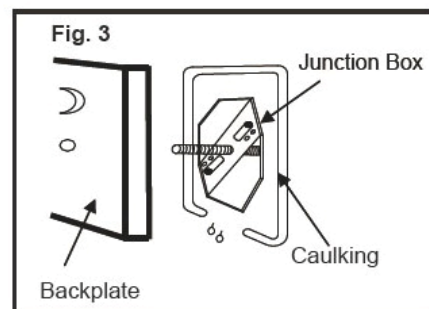
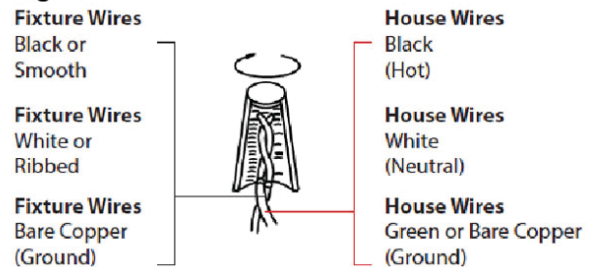

# INSTALLATION INSTRUCTION

## Kyoto - Exterior

WS-W22514



MODERN FORMS  
A WAC LIGHTING COMPANY

### WARNING

IMPORTANT: NEVER attempt any work without shutting off the electricity.

- Read all instructions before installing.
- System is intended for installation by a qualified electrician in accordance with the National Electrical Code and local regulations.
- Go to the main fuse box, or circuit breaker. Place the main power switch in the "OFF" position and unscrew the fuse(s) or switch "OFF" the circuit breaker switch(es) that control the power to the fixture or room that you are working on.
- Place the wall switch in the "OFF" position.

### CAUTION

- All parts must be used as indicated in these instructions. Do not substitute any parts, leave parts out, or use any parts that are worn out or broken. Failure to follow this instruction could invalidate the ETL/CETL listing of this fixture.  
CAUTION When handling the fixture, do not apply pressure to the LEDs. Hold the fixture by the base only.

### AVERTISSEMENT

IMPORTANT : Coupez l'électricité avant TOUTE manipulation.

- Lisez toutes les instructions avant d'installer.
- Système est destiné à être installé par un électricien qualifié en conformité avec le code national de l'électricité et les règlements locaux.
- Accédez au panneau central de disjoncteurs ou de fusibles de votre demeure et placez l'interrupteur principal en position d'arrêt (« OFF »).
- Placez l'interrupteur mural en position d'arrêt (« OFF »).

### MISE EN GARDE

- Toutes les pièces doivent être utilisées tel qu'il est indiqué dans ces instructions. Ne remplacez pas les pièces, n'en laissez pas de côté et ne les utilisez pas si elles sont usées ou brisées. Le non-respect de ces instructions peut annuler l'homologation ETL/CETL du luminaire. MISE EN GARDE Ors de la manipulation de l'appareil, ne pas appliquer de pression à la LED, tenir l'appareil par la seule base.

### ADVERTENCIA

IMPORTANTE: NUNCA intente hacer trabajos sin desconectar el suministro eléctrico.

- Lea y comprenda todas las instrucciones e ilustraciones por completo antes de proceder con el ensamblaje e instalación de esta lámpara.
- Sistema está diseñado para ser instalado por un electricista calificado, de acuerdo con el código eléctrico nacional y las normas locales.
- Diríjase a la caja de fusibles o a la caja del interruptor de circuito principal en su hogar. Coloque el interruptor de alimentación principal en la posición "OFF" (APAGADO).
- Coloque el interruptor de la pared en la posición "OFF" (APAGADO).

### PRECAUCIÓN

- Todas las piezas deben usarse como lo indican estas instrucciones. No reemplace las piezas, no omita piezas durante la instalación ni utilice piezas gastadas o rotas. El incumplimiento de esta indicación podría invalidar la calificación ETL/CETL esta lámpara. PRECAUCIÓN Al manipular el aparato, no aplique presión a los LED, mantenga el aparato en la base sólo.

### HARDWARE

B1



Junction Box  
Screw  
Qty: 2pc  
+ 1 extra

C1



Wire Connector  
Qty: 3pc

E1



Fixture Screw  
Qty: 5pc  
+ 1 extra

F1



Gasket  
Qty: 5pc  
+ 1 extra

I1



Plastic  
Anchor  
Qty: 2pc

J1



Wood Screw  
Qty: 2pc

L1



Set Screw  
Qty: 1pc  
+ 1 extra

### Modern Forms

www.modernforms.com  
Phone (800) 526.2588 • Fax (800) 526.2585

### Headquarters/Eastern Distribution Center

44 Harbor Park Drive • Port Washington, NY 11050  
Phone (516) 515.5000 • Fax (516) 515.5050

### Western Distribution Center

1750 Archibald Ave • Ontario, CA 91761  
Phone (800) 526.2588 • Fax (800) 526.2585



# INSTALLATION INSTRUCTION

## Kyoto - Exterior

WS-W22514



MODERN FORMS  
A WAC LIGHTING COMPANY

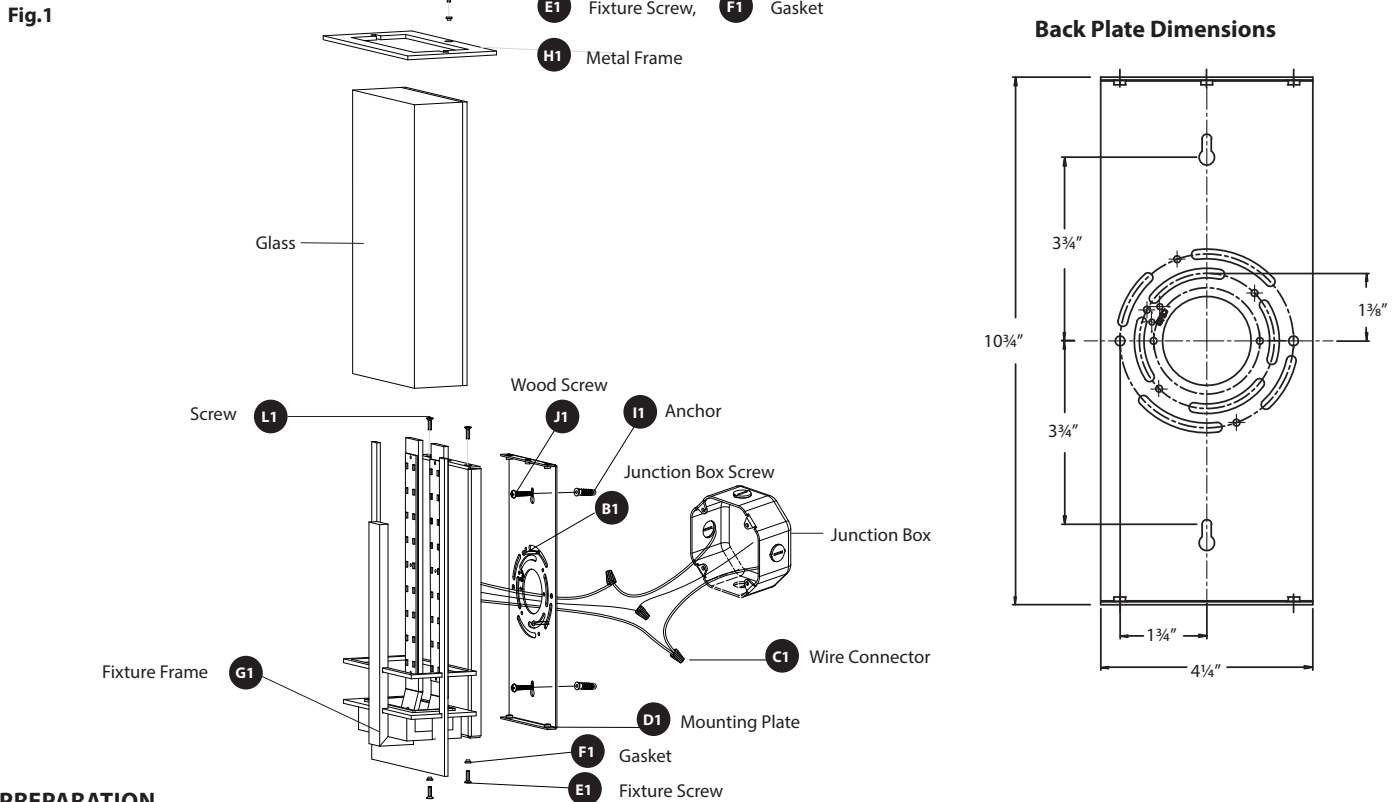

### PREPARATION

- Shut off the power at the circuit breaker and remove existing fixture, including the mounting hardware. Carefully unpack your new fixture and lay out all the parts on a clear area. Be careful not to lose any small parts necessary for installation.

### CONNECTING THE WIRES

1. Connect the fixture wires to supply wires as shown in Fig. 2, making sure that all wire connectors (C1) are secured. If your outlet box has a green or bare copper ground wire, connect the fixture's ground wire to it. Otherwise, connect the fixture's ground wire directly to the mounting plate (D1) using the green screw provided. After wires are connected, tuck them carefully inside the junction box (A1).
2. Drill the holes in the proper position on the wall according to the keyholes located on the mounting plate (D1). Insert the plastic anchors (I1) into the wall.
3. Secure the mounting plate (D1) to the junction box using the junction box screws (B1). Fasten mounting plate (D1) to the wall using the wood screws (J1). The side of the mounting plate marked "GND" must face out.
4. Place the fixture frame (G1) over the mounting plate (D1) and secure with set screws (E1), two at the bottom (L1), two at the top and gasket (F1).
5. Put the glass (K1) to the fixture frame (G1) from the top and put the metal frame (H1) on the glass (K1) secure it to the mounting plate (D1) with screws (E1) and gasket (F1).

### COMPLETING THE INSTALLATION

6. To prevent moisture from entering the outlet box and causing a short, use clear caulking (i.e. indoor/outdoor silicone sealant) to outline the outside of fixture back plate where it meets the wall. Leave a space at the bottom to allow moisture to escape **Fig.3**

**Fig.2 Wiring**

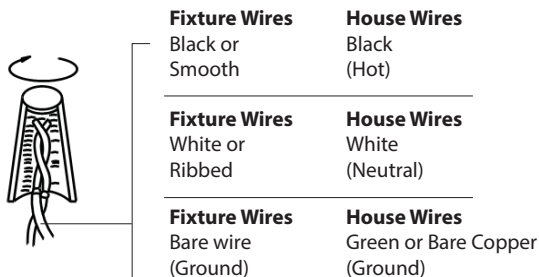

**Fig.3 Sealing**

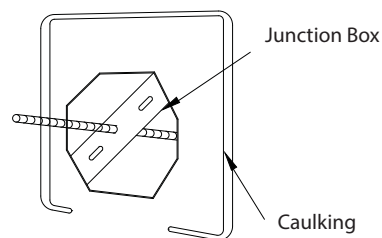

Modern Forms  
www.modernforms.com  
Phone (800) 526.2588 • Fax (800) 526.2585

Headquarters/Eastern Distribution Center  
44 Harbor Park Drive • Port Washington, NY 11050  
Phone (516) 515.5000 • Fax (516) 515.5050

Western Distribution Center  
1750 Archibald Ave • Ontario, CA 91761  
Phone (800) 526.2588 • Fax (800) 526.2585



# INSTALLATION INSTRUCTION

## Kyoto - Exterior

WS-W22520



MODERN FORMS  
A WAC LIGHTING COMPANY

### WARNING

IMPORTANT: NEVER attempt any work without shutting off the electricity.

- Read all instructions before installing.
- System is intended for installation by a qualified electrician in accordance with the National Electrical Code and local regulations.
- Go to the main fuse box, or circuit breaker. Place the main power switch in the "OFF" position and unscrew the fuse(s) or switch "OFF" the circuit breaker switch(es) that control the power to the fixture or room that you are working on.
- Place the wall switch in the "OFF" position.

### CAUTION

- All parts must be used as indicated in these instructions. Do not substitute any parts, leave parts out, or use any parts that are worn out or broken. Failure to follow this instruction could invalidate the ETL/CETL listing of this fixture.
- CAUTION When handling the fixture, do not apply pressure to the LEDs. Hold the fixture by the base only.

### AVERTISSEMENT

IMPORTANT : Coupez l'électricité avant TOUTE manipulation.

- Lisez toutes les instructions avant d'installer.
- Système est destiné à être installé par un électricien qualifié en conformité avec le code national de l'électricité et les règlements locaux.
- Accédez au panneau central de disjoncteurs ou de fusibles de votre demeure et placez l'interrupteur principal en position d'arrêt (« OFF »).
- Placez l'interrupteur mural en position d'arrêt (« OFF »).

### MISE EN GARDE

- Toutes les pièces doivent être utilisées tel qu'il est indiqué dans ces instructions. Ne remplacez pas les pièces, n'en laissez pas de côté et ne les utilisez pas si elles sont usées ou brisées. Le non-respect de ces instructions peut annuler l'homologation ETL/CETL du luminaire. MISE EN GARDE Ors de la manipulation de l'appareil, ne pas appliquer de pression à la LED, tenir l'appareil par la seule base.

### ADVERTENCIA

IMPORTANTE: NUNCA intente hacer trabajos sin desconectar el suministro eléctrico.

- Lea y comprenda todas las instrucciones e ilustraciones por completo antes de proceder con el ensamblaje e instalación de esta lámpara.
- Sistema está diseñado para ser instalado por un electricista calificado, de acuerdo con el código eléctrico nacional y las normas locales.
- Diríjase a la caja de fusibles o a la caja del interruptor de circuito principal en su hogar. Coloque el interruptor de alimentación principal en la posición "OFF" (APAGADO).
- Coloque el interruptor de la pared en la posición "OFF" (APAGADO).

### PRECAUCIÓN

- Todas las piezas deben usarse como lo indican estas instrucciones. No reemplace las piezas, no omita piezas durante la instalación ni utilice piezas gastadas o rotas. El incumplimiento de esta indicación podría invalidar la calificación ETL/CETL esta lámpara. PRECAUCIÓN Al manipular el aparato, no aplique presión a los LED, mantenga el aparato en la base sólo.

### HARDWARE

B1



Junction Box  
Screw  
Qty: 2pc  
+ 1 extra

C1



Wire Connector  
Qty: 3pc

E1



Fixture Screw  
Qty: 5pc  
+ 1 extra

F1



Gasket  
Qty: 5pc  
+ 1 extra

I1

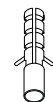

Plastic  
Anchor  
Qty: 2pc

J1



Wood Screw  
Qty: 2pc

L1



Set Screw  
Qty: 1pc  
+ 1 extra

### Modern Forms

www.modernforms.com  
Phone (800) 526.2588 • Fax (800) 526.2585

### Headquarters/Eastern Distribution Center

44 Harbor Park Drive • Port Washington, NY 11050  
Phone (516) 515.5000 • Fax (516) 515.5050

### Western Distribution Center

1750 Archibald Ave • Ontario, CA 91761  
Phone (800) 526.2588 • Fax (800) 526.2585



# INSTALLATION INSTRUCTION

## Kyoto - Exterior WS-W22520



**MODERN FORMS**  
A WAC LIGHTING COMPANY

Fig.1

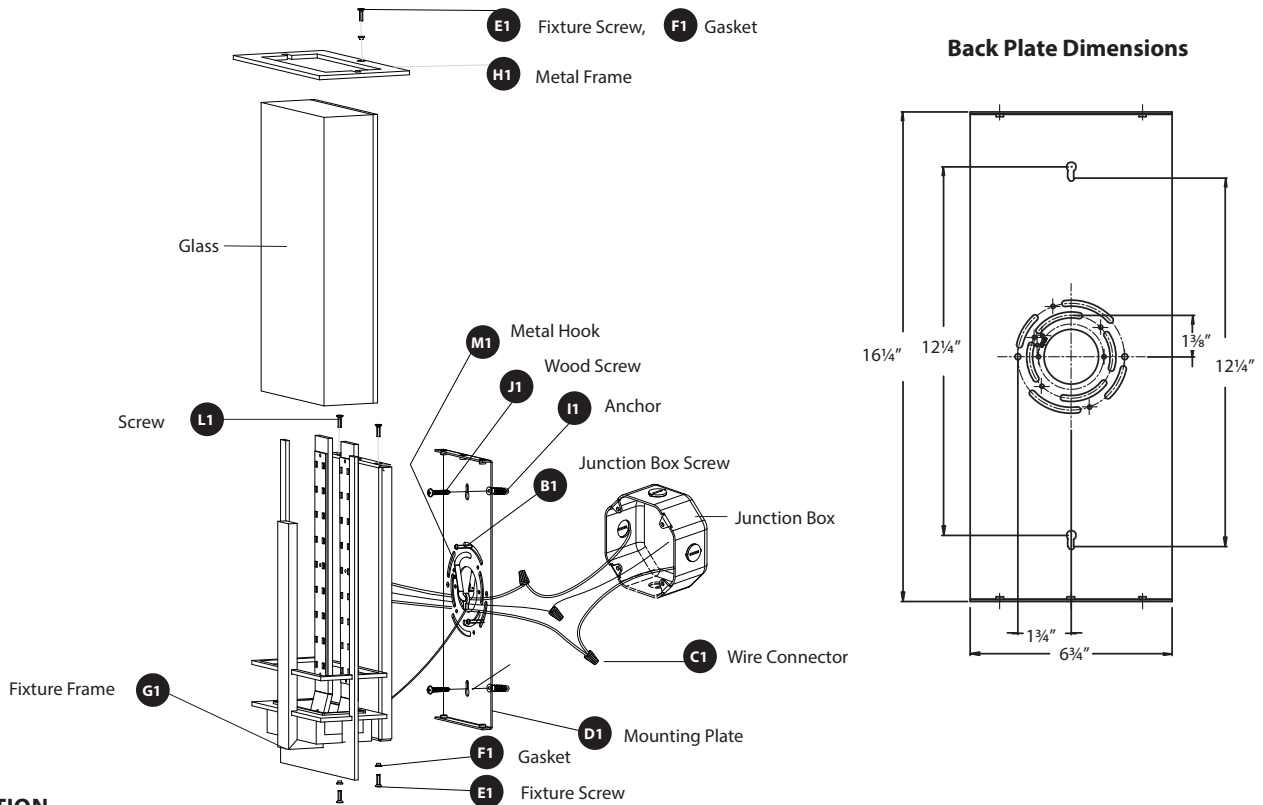

### PREPARATION

- Shut off the power at the circuit breaker and remove existing fixture, including the mounting hardware. Carefully unpack your new fixture and lay out all the parts on a clear area. Be careful not to lose any small parts necessary for installation

### MOUNTING THE FIXTURE (FIG. 1)

1. Drill holes in the proper position on the wall according to the keyholes located on the mounting plate (D1). Insert the plastic anchors (I1) into the wall.
2. Secure the mounting plate (D1) to the junction box (A1) using the junction box screws (B1). Fasten mounting plate (D1) to the wall using the wood screws (J1). The side of the mounting plate marked "GND" must face out.
3. Lock the metal hook (M1) of the safety cable onto the mounting plate.

### CONNECTING THE WIRES

4. Connect the fixture wires to supply wires as shown in Fig. 2, making sure that all wire connectors (C1) are secured. If your outlet box has a green or bare copper ground wire, connect the fixture's ground wire to it. Otherwise, connect the fixture's ground wire directly to the mounting plate (D1) using the green screw provided. After wires are connected, tuck them carefully inside the junction box (A1).
5. Place the fixture frame (G1) over the mounting plate (D1) and secure with set screws (E1) two at the bottom (L1), two at the top and gasket (F1).
6. Put the glass (K1) in the fixture frame (G1) from the top and put the metal frame (H1) on the glass (K1) secure it to the mounting plate (D1) with screws (E1) and gasket (F1).

### COMPLETING THE INSTALLATION

7. To prevent moisture from entering the outlet box and causing a short, use clear caulking (i.e. indoor/outdoor silicone sealant) to outline the outside of fixture back plate where it meets the wall. Leave a space at the bottom to allow moisture to escape **Fig.3**

Fig.2 Wiring

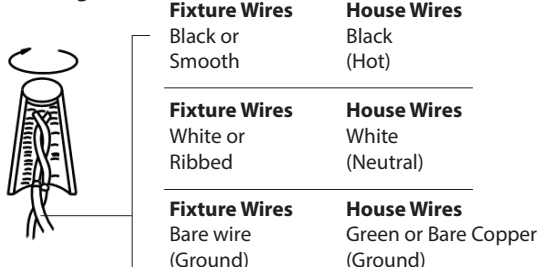
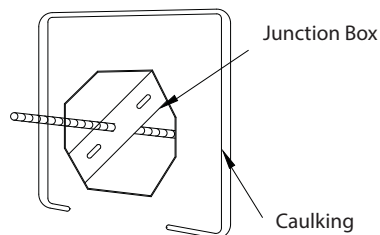

Fig.3 Sealing



Modern Forms  
www.modernforms.com  
Phone (800) 526.2588 • Fax (800) 526.2585

Headquarters/Eastern Distribution Center  
44 Harbor Park Drive • Port Washington, NY 11050  
Phone (516) 515.5000 • Fax (516) 515.5050

Western Distribution Center  
1750 Archibald Ave • Ontario, CA 91761  
Phone (800) 526.2588 • Fax (800) 526.2585

