

160.1400 | Kitchen / Bar Faucet

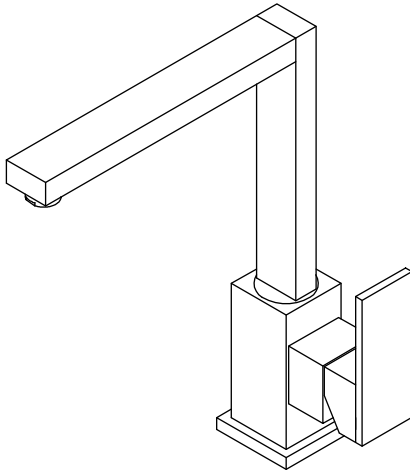

SPECIFICATIONS:

- Solid Brass construction
- Single Hole Installation
- 1.8 GPM Flow Rate @ 60 PSI
- Ceramic disc cartridge allows both volume and temperature control

FINISHES :

- Chrome - 160.1400CP, Brushed Nickel - 160.1400BN

STANDARDS:

- ASME A112.18.1 / CSA B125.1, NSF-61 & EPA Watersense

LowFlow Capable



Legislation Compliance



Low Lead Compliant



ZeroDrip Technology



Technical Diagram

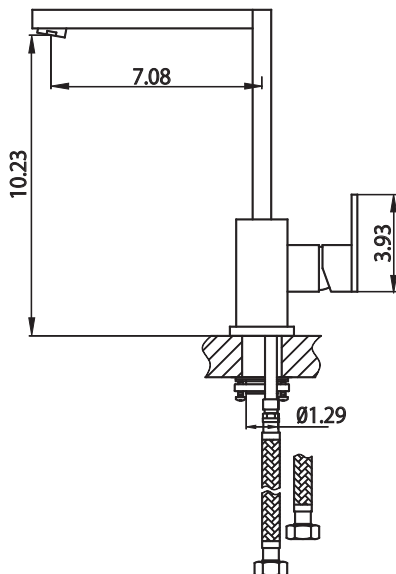

Exploded View

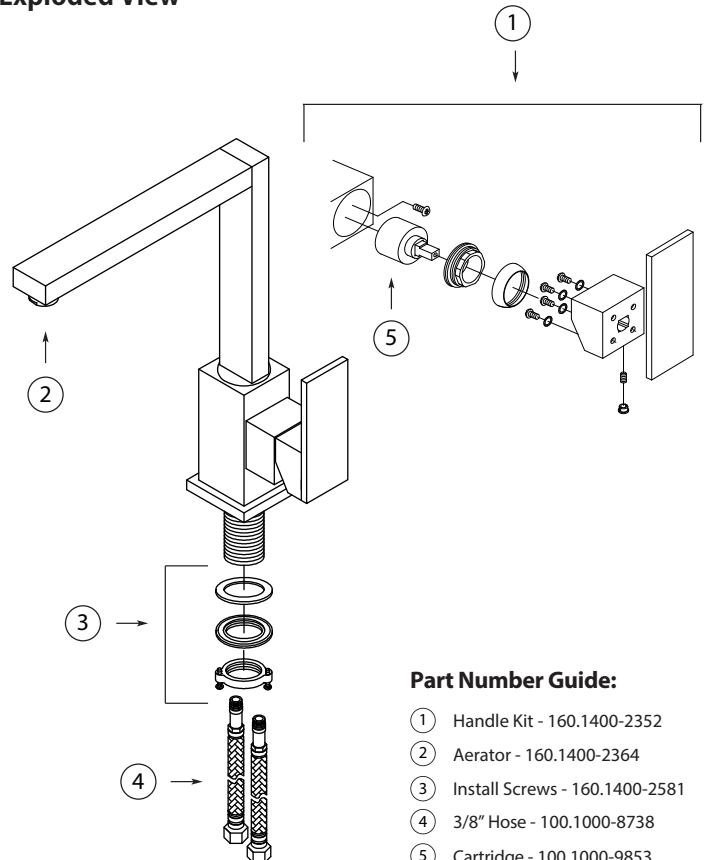

Part Number Guide:

- ① Handle Kit - 160.1400-2352
- ② Aerator - 160.1400-2364
- ③ Install Screws - 160.1400-2581
- ④ 3/8" Hose - 100.1000-8738
- ⑤ Cartridge - 100.1000-9853