

INSTALLATION INSTRUCTIONS



2-Handle Thermostatic Rough with Volume Controls

Model: D35005511.191

*If designated with an "S", the valve offers shared flow position between adjacent outlets.

For use with shower heads rated at 4.9 L/min (1.3 gpm) or higher.

Thank you for selecting DXV. To ensure that your installation proceeds smoothly, please read these instructions carefully before you begin.

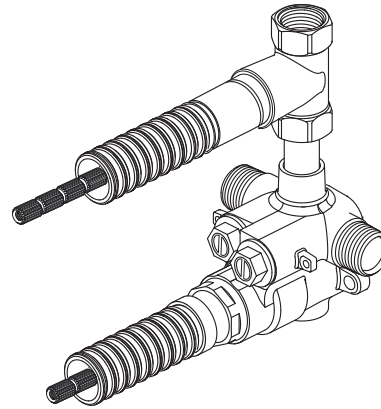

RECOMMENDED TOOLS AND MATERIALS

Most of the procedures require the use of common tools and materials, which are available from hardware and plumbing supply stores. It is essential that the tools and materials be on hand before work has begun.



Channel Locks

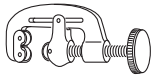

Tubing Cutter



Adjustable Wrench



Teflon Tape

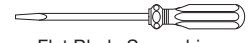

Flat Blade Screwdriver
(provided)

ROUGHING-IN DIMENSIONS:

- Connections are: 1/2" NPT

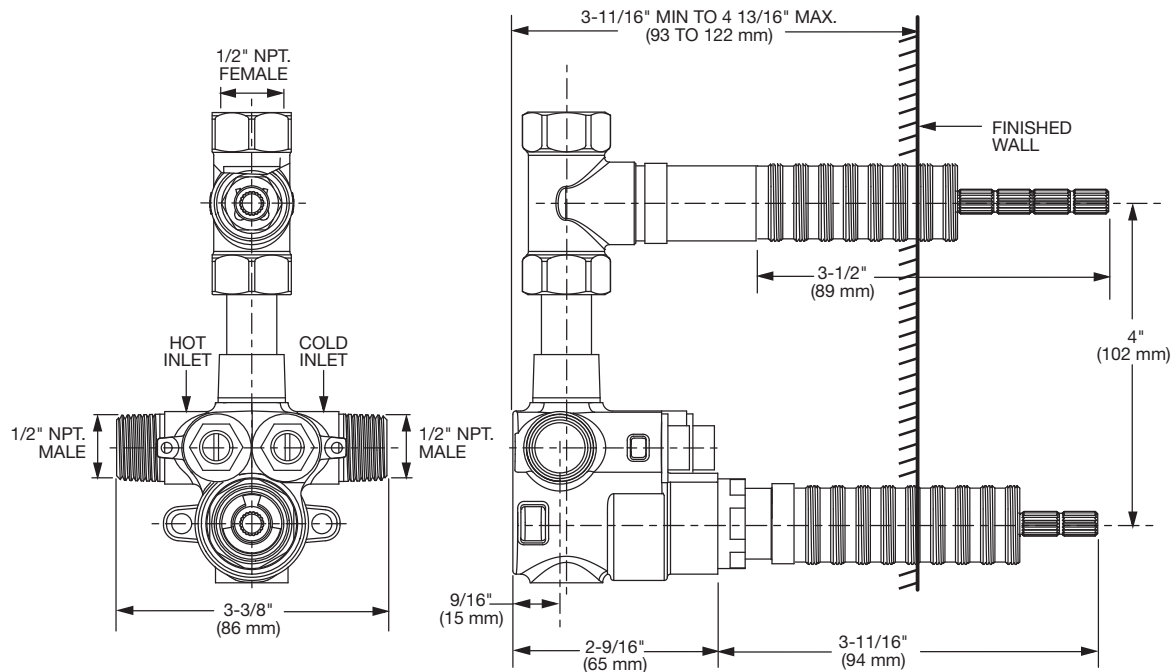

SAVE FOR FUTURE USE

1 ROUGHING-IN THE VALVE

CAUTION DO NOT SOLDER NEAR THE VALVE. DAMAGE TO THE SEALS MAY OCCUR.
DO NOT SEAL ANY OUTLETS. THIS DIVERTER CANNOT BE USED AS A STOP VALVE.

- Prepare water supplies per ROUGHING-IN DIMENSIONS. Make sure the finished wall is between the minimum and maximum rough dimension.
- Install VALVE at indicated height and depth. Make sure the “hot inlet” (RED) is on the left-hand side and the “cold inlet” (BLUE) is on the right-hand side
 - Connect the hot and cold water supplies. Assemble all connecting pipes. Flush lines to remove any dirt. Connections are 1/2" NPT.
- Assemble the connection pipes to the MIXED OUTLETS of the VALVE.
- If the CHECK STOPS (1,2) were removed during installation, ensure the hot and cold CHECK STOPS (1,2) are not reversed. The hot CHECK STOP (1) has a red top and the cold CHECK STOP (2) has a blue top.
- To flush lines, remove the CHECK STOPS (1,2) and run water. If desired, the TEMPERATURE CONTROL UNIT can be removed. Reinstall CHECK STOPS (1,2).
- Beware of Freezing. No water should remain in the MIXING VALVE if freezing is a possibility. Remove the CHECK STOP (1,2) to completely drain the MIXER UNIT (1).

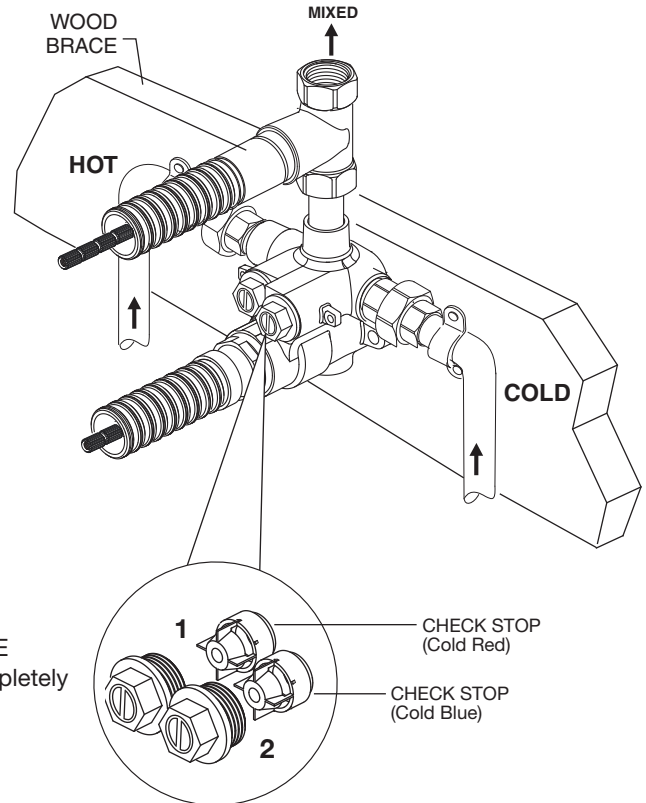

2 INNER AND OUTER SPLINE ADJUSTMENT

Note: Inner Spline and Outer Tube should only be cut after they're removed from the valve.

1. Mark a position where the outer TUBE (1) needs to be cut. Remove by unthreading.
2. After cutting, replace outer TUBE (1) by threading it back onto the valve firmly.
3. Mark the position of the inner SPLINE (2) and unthread by using a Flat Head Screw Driver (Provided).
4. Cut to the necessary length and install inner Spline back onto the valve.

Note: The inner Spline needs to be replaced in the same rotary position for the handle to be installed in a neutral position.

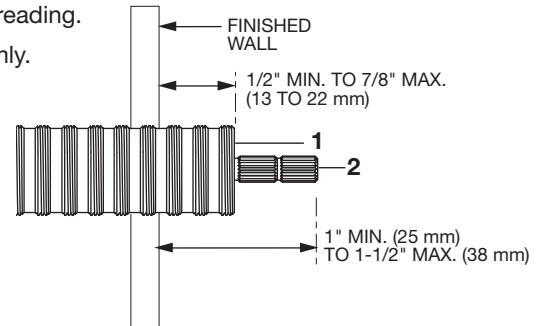

3 ADJUST HOT LIMIT STOP

By restricting HANDLE rotation and limiting the amount of hot water allowed to mix with the cold, the HOT LIMIT SAFETY STOP (1) reduces risk of accidental scalding. To set the maximum hot water temperature of your faucet, all you need to do is adjust the setting on the HOT LIMIT SAFETY STOP (1).

- Use a flat blade screwdriver to pry free the HOT LIMIT SAFETY STOP (1). Pull forward and rotate counterclockwise one tooth to reduce maximum hot water temperature. The maximum temperature is nominally factory set to 120°F. The temperature variation is approximately 4°F per tooth. Always check water temperature maximum before completing the installation.

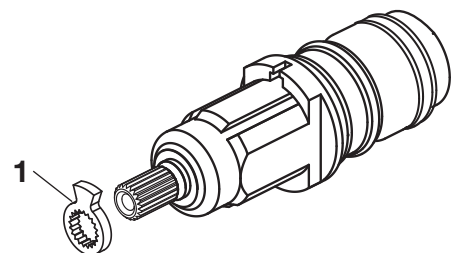



2-Handle Thermostatic Rough with Volume Controls

MODEL NUMBER

D35005511.191

1	M970400-0070A	CARTRIDGE FOR DIVERTER
2	M970401-0070A	CHECK VALVE KIT
3	M970402-0070A	CHECK STOP KIT
4	M970403-0070A	HANDLE EXTENSION FOR DIVERTER
5	M970405-0070A	THERMO CARTRIDGE
6	M970406-0070A	CARTRIDGE NUT
7	M970409-0070A	HANDLE EXTENSION FOR THERMO

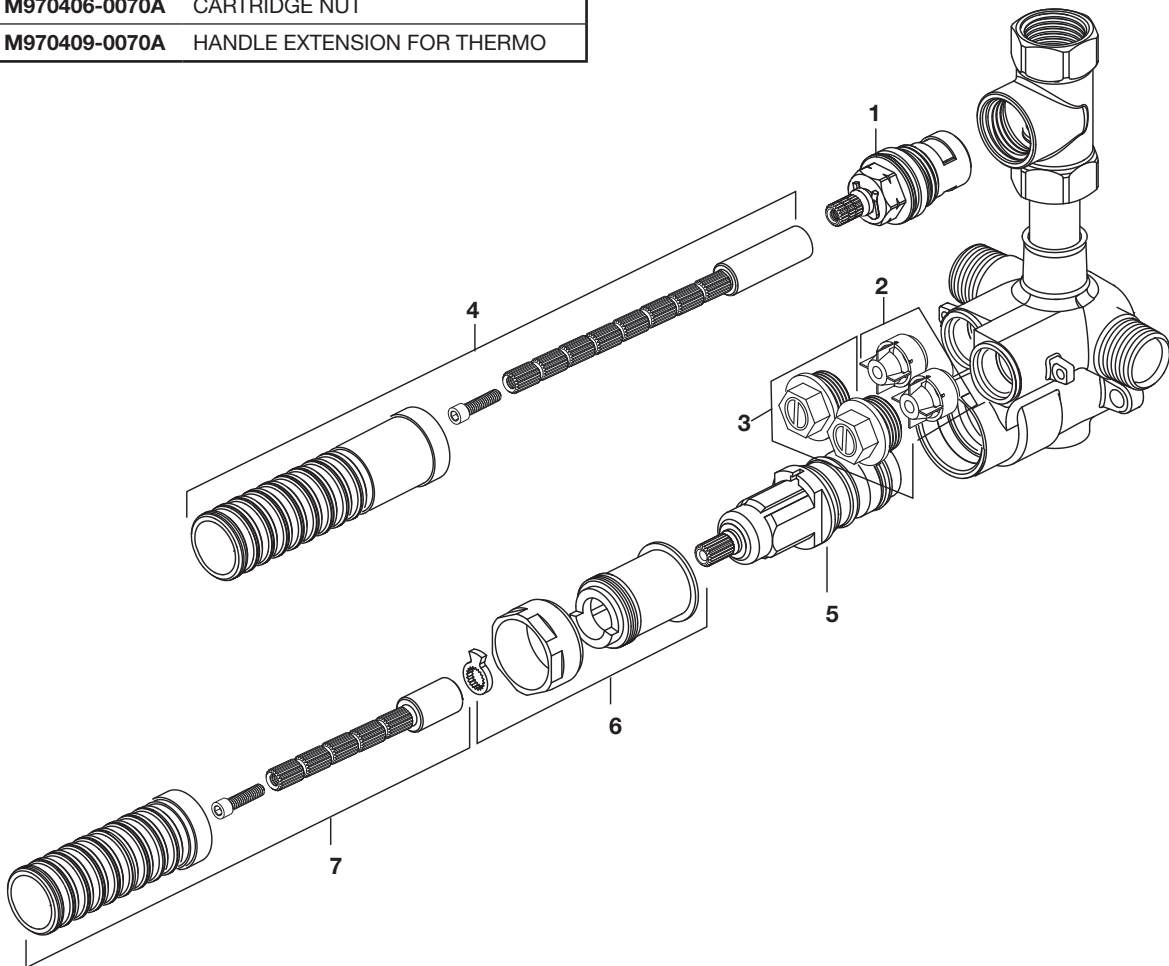

In the United States:

DXV
One Centennial Avenue
Piscataway, New Jersey 08855
Attention: Director of Customer Care

For residents of the United States, warranty information may also be obtained by calling the following toll free number: (800) 227-2734
www.DXV.com

In Canada:

DXV
5900 Avebury Road
Mississauga, Ontario
L5R 3M3
Canada

Toll Free: 1-800-387-0369
Local: 905-306-1093
Fax: 1-800-395-1498
www.DXV.ca

In Mexico:

DXV
Via Morelos 330
Col. Santa Clara Coatitla
Ecatepec, Estado de México 55540

Toll Free: 01-800-8391200
www.DXV.mx